

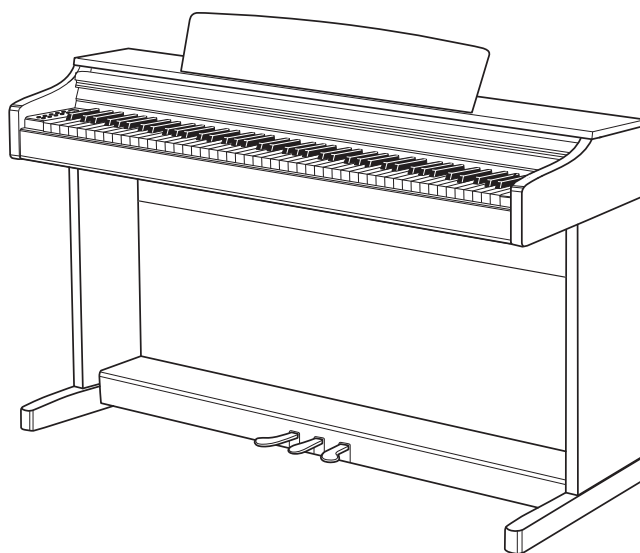

OWNER'S MANUAL

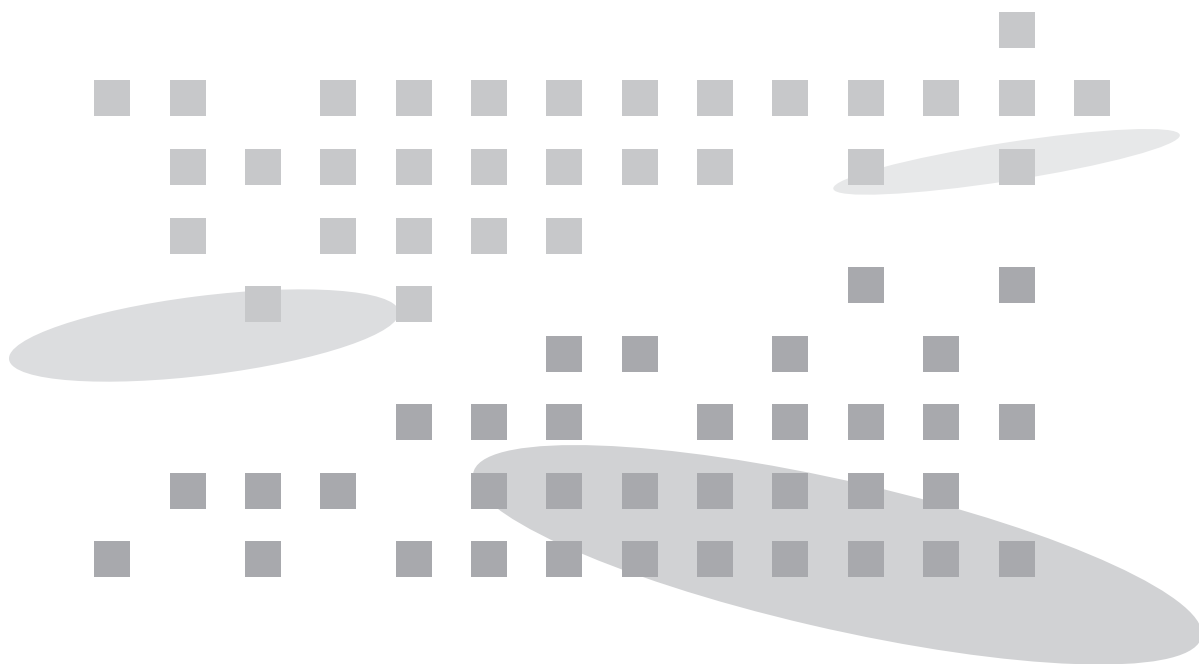

High Performance USB Digital Piano
New feel, new look and new sound

Before Reading:

Safety Instructions

This section is intended to ensure the user's safety and prevent financial damage. Please read this section carefully and use the product properly according to it.



WARNING: Not following this warning may result in serious physical injury!



CAUTION: Not following this caution may result in injury and/or financial loss!



WARNING:

To avoid the risk of death or physical injury due to electric shock, short circuit, damage or fire, please follow the fundamental safety instructions listed below:

- Never open up this product or attempt to break down or modify its inner parts. This product contains no user-serviceable components. If it seems to be malfunctioning, please immediately cease use of the product and contact customer service for repair.
- Do not expose the product to rain. Do not use this product under watery or wet environment, and do not leave any liquid container on its top as it may spill into the product. If any liquid is spilled into the product, immediately turn off the product, take the plug off the AC outlet and contact a designated service center for inspection.
- If the power cable or plug is either worn off or damaged, or the product suddenly stops sounding, or any unknown smell or smoke seem to emerge from the product, immediately turn off the product, take the adapter plug off the AC outlet and contact a designated service center for inspection.
- Always use the correct voltage for this product. The voltage specification can be found on the name label located behind this product.
- Always take the plug off the outlet prior to cleaning the product. Never insert or take off the plug with wet hands.
- Regularly check the condition of the power plug, and remove any substances or dusts that may have accumulated on it.



CAUTION

To avoid the risk of physical injury, damage of this product or other financial loss, please follow the fundamental safety instructions listed below. This caution includes the following:

- Do not place the power cable nearby heat generators like heaters or radiators. Bending the cable too much could damage the cable. Do not put heavy objects on the cable, or leave the cable on a location where others may step on or trip over it.
- When removing the plug from either the product or the outlet, always seize the neck of the plug. Seizing and pulling from the cable could damage it.
- Do not use multi-connectors to power the product. Doing so may result in lowered sound quality and/or overheat the outlet.
- When not using the product for an extended period of time, or during an electric storm, take the plug off the outlet.
- When connecting this product to another electronic product, turn off the powers of both products before connecting. Set the volumes of all products to minimum before turning on the products. After making sure that all volumes are set to minimum, begin using this product and gradually increase the volume until the desired level is reached.
- When using USB or AUX in/out(RCA), use a cable with ferrite cores.
- Do not expose this product to excessive dust, vibration, or locations/sources of extreme heat (under direct sunlight, nearby heaters, inside cars during daytime). Exposure to such environments may result in external and/or internal damage.
- Do not use this product nearby devices like TVs, radios, stereo sound devices, mobile phones or other electronic devices. Doing so could result in excessive noise from either this product or the TV/radio.
- Do not place the product on unstable locations where it may fall off.
- Always remove all cables from the product before moving it.
- When cleaning the instrument, always use soft and dry or lightly wet cloth. Do not use cloth imbued with paint diluent, solvent, cleansing agent or chemical substances. Do not place any objects made of vinyl, plastic or rubber on the product. Doing so may alter the color of the keys or the panel.
- Do not place your weight or heavy objects on the product.
- Do not use excessive force while manipulating the buttons, switches or connectors.
- Be careful not to leave fingers below the key cover when closing it. Do not insert fingers below the key cover or into any other gap between the parts of this product.
- Do not insert or drop objects like paper or metal substances on the key cover, panel, or in the gap between keys. When done so accidentally, immediately turn off the power of the product, take the plug off the outlet, and contact a designated service center.
- Maintain 3 inches of space between the piano and the wall or other nearby objects. Insufficient space may interfere with air circulation and result in overheat.
- Carefully read the guide on assembling procedure and follow the instructions. Not doing so could result in damage of the instrument and/or injury of the user.
- Avoid using the product on volume high enough to be disturbing to ears for extended period of time, as doing so could affect one's hearing permanently. If you experience hearing difficulty, or excessive ringing on the ears, contact a physician.
- During thunderstorms, take the plug off the outlet.

Product Features

We thank you for purchasing our digital piano!

This product contains a maximum polyphony of 81 notes and a sound data collection as much as 256Mbit to offer high quality voices.

There are the two-track recording system designed to aid the learning process, a USB terminal for computer music and stereo audio terminals for audio devices like MP3 player.

Also, this piano has the pedagogical etude series of Beyer, Czerny, Burgmüller and selected sonatines by many composers for playing reference.

To take full advantage of the wide range of features and utilities offered on this instrument, please read and examine this owner's manual thoroughly.

Please keep this owner's manual for future reference.

Thank you.

Table of Contents

Before Reading...	1	Functions	23
Safety Instructions	1	Using Setup	23
Product Features	3	Master Tune	24
Table of Contents	4	Key Transpose	24
Product Components	5	Brilliance	24
Assembly	6	Touch	24
Parts	8	Fixed Touch Velocity	25
Power Switch	8	Demo Volume	25
Headphone Jacks	8	Play All Music	25
Connections	9	Metronome Volume	25
Pedals	10	Reverb Type	25
Control Panel	11	Effect Type	25
Basic Controls	12	Reverb Volume	26
Adjusting Volume	12	Effect Volume	26
Choosing a Voice	12	MIDI Local Control	26
Using PIANO	12	Hybrid USB Audio	26
Dual Mode	13	Reset	26
Layer	13	MEMO	27
Split	14	MIDI Chart	28
Changing the Split Point	14	GM Voice & Percussion	29
Secondary Volume	15	GM Voice	29
Twin Piano	15	Percussion	30
Metronome	16	Trouble shooting	31
Record	17	Product Specifications	32
Recording	17		
Playing	17		
Erasing	17		
Demo / Etude	18		
Listening to Music	18		
Adjusting Tempo	19		
Adjusting Volume	19		
Demo List	20		
Beyer / Czerny Etudes	21		
Burgmüller Etudes / Sonatines	22		

Product Components

After purchasing the product, carefully unpack it and examine the existence and condition of the items listed below. If an item is missing or damaged, contact the place of purchase.

Main Unit

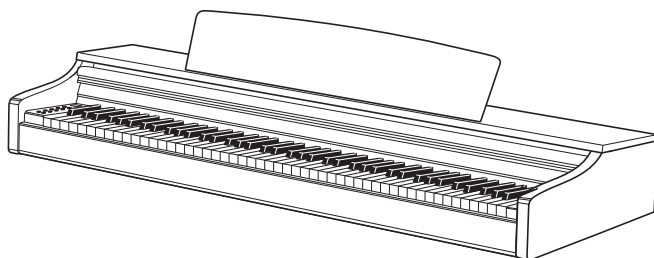

Left/Right Legs(a, b)

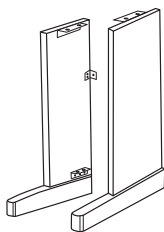

Pedal Plate(c)

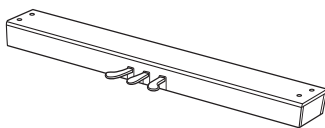

Backplate(d)

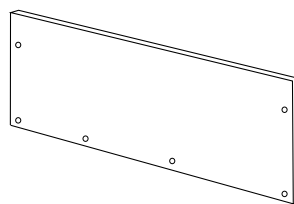

Pedal Plate Fixers
(e) (M6 ×25)mm, 4EA

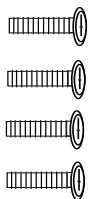

Backplate Fixers
(f) (M3.5 ×25)mm, 4EA
(g) (M4×13)mm, 2EA

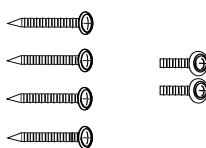

Main Unit Fixers
(h) (M6 ×15)mm, 2EA



AC Adapter

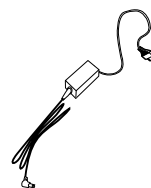

☞ Keeping the original packing materials can be very useful in the event where you need to re-pack the product in order to move it to a faraway location.

Assembly

1 Assembling the legs and pedals

1 Place the **pedal plate (c)** between the **legs (a, b)** like the picture below and use the **pedal plate fixers (e)** to fix the pedal plate.

2 Manipulate the pedal plate knob (see picture) so that it would be in firm contact with the floor on which the piano is installed.

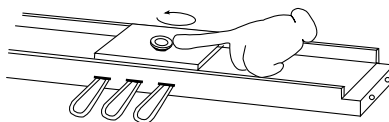
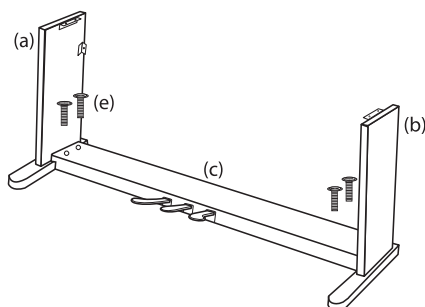

2 Assembling the backplate

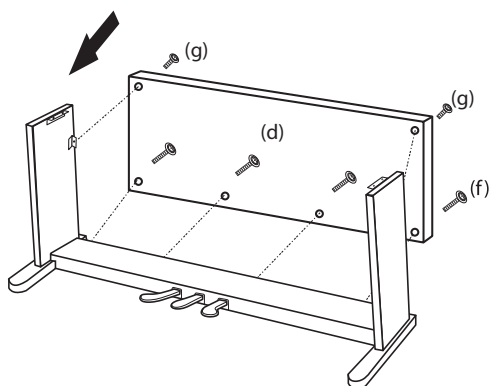

1 Place the **backplate (d)** between the leg by inserting it from behind.

2 Use the **backplate fixers (f), (g)** to fix the backplate.

3 Make sure that the plate is maintaining the right angle.

3 Assembling the main unit

- 1 Place the main unit onto the assembled lower body by pushing it from behind so that the screws (2EA) fixed under the main unit would fit into the rear holes of the brackets attached to the legs.
- 2 Use **main body fixers (h)** on the other holes of the brackets to secure the connection between the bodies.
- 3 Firmly tighten all 4 screws to finish the assembly.

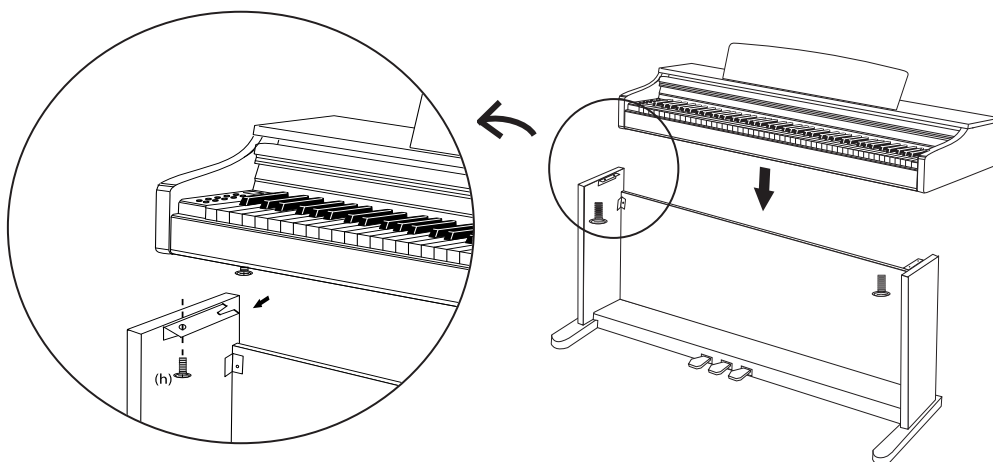

- 4 Raise the scoreboard on the top of the main unit and use the brackets on its back to keep it standing.

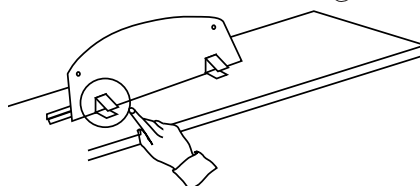

4 Connecting the pedal & power cables

- 1 Connect the pedal cable from the pedals to the pedal jack beneath the main unit. The pedal cable is tied below the pedal box.

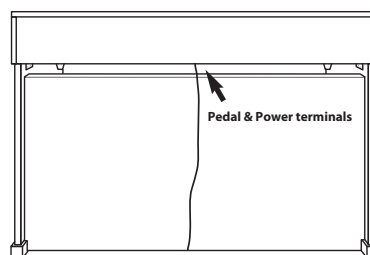
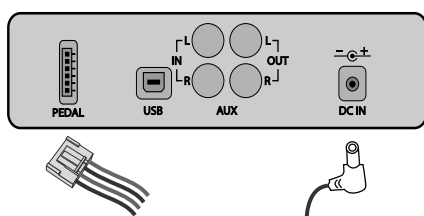

Parts

Power Switch

Power Switch (on the right of the keyboards)

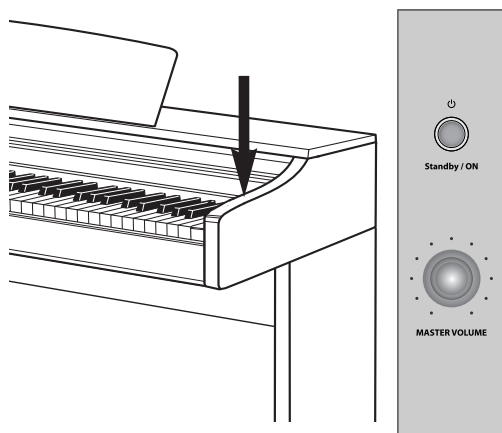

Insert the DC plug of the AC adaptor into the piano and AC plug into a household AC power outlet, and press the Standby/ON switch to turn on the piano.

- ☞ When the piano is first turned on, the initial default voice is 'Grand Piano 1(G.P1)'
- ☞ Use the **MASTER VOLUME** knob to adjust the volume.

All parameters and settings except for the recording are initialized whenever the piano is turned off and on again.

Auto Power Off(APO)

This product features an auto power management system which turns off the instrument automatically when left unused for 30 minutes.

Deactivating Auto Power Off(APO)

While holding down the first white key and first black key from the left, press the power switch to deactivate APO.

Headphone Jacks

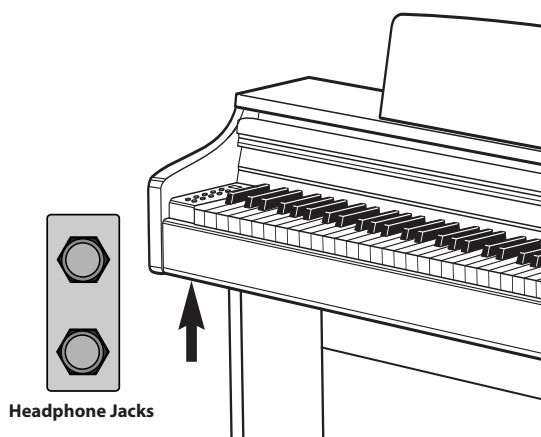

Two headphone jacks are located on the left beneath the main unit.

- ☞ When a headphone is connected to the piano, the speakers of the piano are muted.
- ☞ Two headphone jacks exist, allowing up to two people to listen simultaneously.
- ☞ The type of headphones for use is limited to the stereo 6.35mm (1/4 inch). If seeking to use the 3.5mm headphones, an extra converter (3.5mm -> 6.35mm) will be required.
- ☞ Headphones are sold separately.

Connections

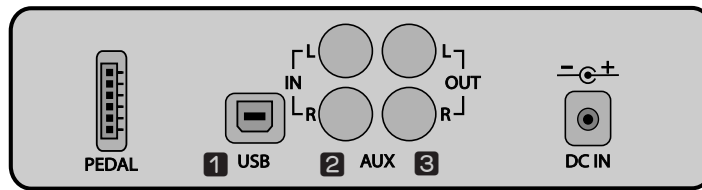

External Connection Terminals(on the bottom of the piano)

1 Connecting to a Computer(USB TO HOST)

The piano features a USB-to-host terminal to allow connecting directly to a computer. By using this jack, the piano and computer may exchange MIDI data via USB.

- 1 Use a USB cable (sold separately) to connect the piano to the computer.
- 2 To use the piano as a MIDI device, run the MIDI software installed on the computer, and set the input/output device of the software to the USB audio device.
- 3 To use the piano as an audio device, go to 'Function' menu and turn on the 'Hybrid USB Audio'.(Refer to Page 23) Next, connect the piano to the computer via USB and set the computer's audio device to the piano.

- ☞ Some notes may be lost when connected via USB.
- ☞ If you use the piano as an audio device, the piano sound is able to be recorded on the computer.
- ☞ Usable on Windows XP or higher, and Mac OS X.
- ☞ No extra driver is required since it utilizes the common Windows device driver.
- ☞ If the device is not recognized, or the USB audio device is not seen on the list of the device setup menu, check the USB cable and ensure proper connection.
- ☞ If connecting the instrument to a computer causes the computer to crash or stop functioning, do not reattempt the connection (doing so may damage the computer or the piano) and immediately contact customer service.

2 AUX IN(RCA)

By connecting external devices to this jack the piano may play via its internal speakers soundtracks provided by external sources such as smart devices or MP3 audio devices.

Connect the output terminal of laptops, smart devices, MP3 players and the AUX IN of the piano using an audio cable (sold separately) to reproduce the audio data of the devices through the piano's speaker system.

3 AUX OUT(RCA)

This jack is used when the use of a more powerful external sound producer (amplifiers etc.) is desired to reproduce the audio output of the piano.

Use an audio cable (sold separately) to connect the AUX OUT of the piano and the input jack of the external device to hear the piano through the external device.

- ☞ When connecting to an external device using the AUX IN/OUT terminal, always turn on the external device first before turning on the power of the piano. When quitting the use of the external device, reverse the order and turn the piano off first before turning off the external device.
- ☞ The audio connection jacks are RCA connectors.

Pedals

The piano consists of three pedals that correspond to the three pedals of an acoustic piano.

Connecting the Pedal Cables

Retrieve the pedal cable tied below the pedal box, and connect it to the pedal input located below the main body.

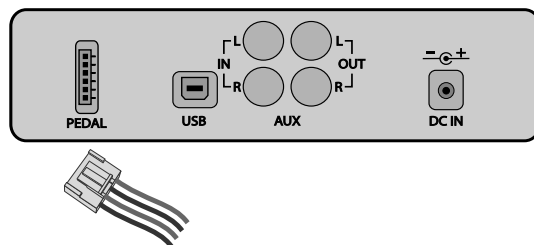

Pedal Functions

1 Sustain Pedal (Right Pedal)

This pedal performs the same function as the sustain pedal of an acoustic piano; playing notes while keeping this pedal pressed will sustain the notes even if the keys have been released.

2 Sostenuto Pedal (Middle Pedal)

This pedal performs the same function as the sostenuto pedal, which is the middle pedal of an acoustic grand piano. It behaves similarly to the sustain pedal, but only the notes that are being played at the moment the sostenuto pedal is pressed will be retained. Notes that are played after the pedal was pressed will not be affected, even if the pedal is kept pressed.

3 Soft Pedal (Left Pedal)

This pedal performs the same function as the soft pedal of an acoustic piano. Pressing this pedal causes the sound of the piano to be muffled a little bit and softens its character.

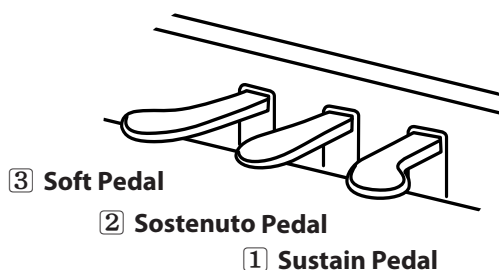

Control Panel

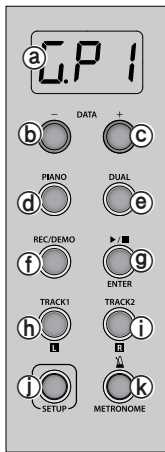

- a LED Screen
- b DATA Down
- c DATA Up
- d PIANO Page 12
- e DUAL Page 13
- f REC/DEMO Page 17,18
- g ▶/■/ENTER Page 17,18,26
- h TRACK1/L Page 17,18
- i TRACK2/R Page 17,18
- j SETUP Page 23
- k METRONOME Page 16, 19, 25

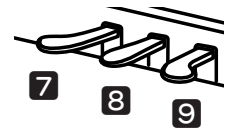
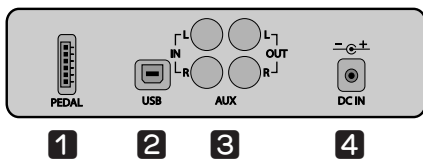

CONNECTIONS

- 1 PEDAL Page 7,10
- 2 USB Page 9,26
- 3 AUX IN/OUT Page 9

POWER

- 4 DC IN Page 7
- 5 Power Switch Page 8

VOLUME CONTROL

- 6 MASTER VOLUME Page 8,12

PEDALS

- 7 Soft Pedal Page 10
- 8 Sostenuto Pedal Page 10
- 9 Sustain Pedal Page 10

Basic Controls

Adjusting Volume

Adjusting Master Volume

Use the **MASTER VOLUME** knob to adjust the overall volume of the piano.

☞ This also affects the volume of headphones.

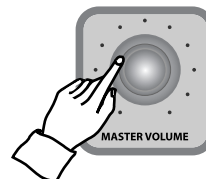

Choosing a Voice

This product is a high class digital piano which offers the refined deep sound of quality acoustic grand pianos along with the sound of other diverse acoustic and electric musical instruments.

1 Voice Types

The voices consist of 18 main voices, 1 percussion kit and 1 sound effect set.

The piano is capable of interpreting the MIDI standards, and once connected to a computer it is able to exploit the full range of the 128 General MIDI voices.

List of Voices

LED	Voice	LED	Voice	LED	Voice	LED	Voice
G.P1	Grand Piano1	Vbr	Vibraphone	Str	Strings	SAP	Alto Saxophone
G.P2	Grand Piano2	P.Or	Pipe Organ	SL.S	Slow Strings	Gut	Nylon Guitar
E.P1	Elec. Piano1	E.O1	Elec. Organ1	FLt	Flute	Ac.b	Acoustic Bass
E.P2	Elec. Piano2	E.O2	Elec. Organ2	brS	Brass	dru	Drum Set
HSC	Harpsichord	Acd	Accordion	S.Ld	Synth Lead	S.EF	Sound Effect

2 Selecting the voice

Press **DATA** buttons to select the desired voice.

- ☞ When the piano is turned on, the initial default voice is 'Grand Piano 1(G.P1)'.
- ☞ The LED will display the chosen voice and change the voice with **DATA** buttons.
- ☞ Hold down a **DATA** button to quickly run through the voices.

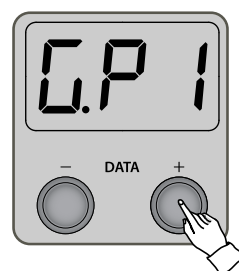

Using PIANO

When the **PIANO** button is pressed, the 'Grand Piano1(G.P1)' is selected as the main voice and the dual mode will be turned off.

- ☞ When the **PIANO** button is pressed, it flashes 3 times.
- ☞ It doesn't work in the recording mode.
- ☞ Refer to page 13 for 'dual mode' and page 17 for 'recording'.

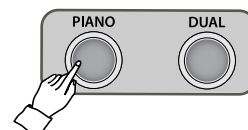

Dual Mode

The Dual Mode consists of Layer, Split and Twin Piano. Choose the desired mode with pressing the **DUAL** button repeatedly. Each time pressing the **DUAL** button, the mode changes.

Layer(LAr) → Split(SPL) → Twin Piano(tn) → Quit



Layer

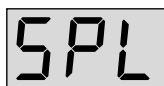

Split

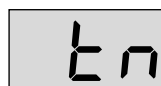

Twin Piano

☞ When the dual mode is turned off, the LED display returns to previous screen.

Layer

Layer allows the player to sound two voices simultaneously when playing a key.

1 Choose the desired main voice first.

Refer to page 12 for voice selection.

2 Press DUAL button.

When **DUAL** button is pressed, the layer mode is selected with displaying 'LAr'. After displaying 'LAr', the layer voice is displayed on the screen.

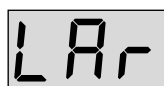
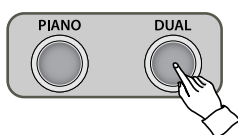

Layer



Slow Strings

☞ The default layer voice is Slow Strings(SL.S).

3 Choose the desired layer voice.

Press **DATA** buttons to choose the layer voice.
Refer to page 12 for voice selection.

☞ The layer volume may be adjusted. Refer to Page 15.

4 Press DUAL button 3 times to turn off the layer.

Layer(LAr) → Split(SPL) → Twin Piano(tn) → Quit

Split

Split divides the piano keyboard into two sections, and allows the player to assign different voices to each of the sections. For example, by using Split the melody part on the right could be played in piano voice while the accompaniment on the left sounding in acoustic bass voice.

1 Choose the desired main voice first.

The main voice will be assigned to the right part. Refer to page 12 for voice selection.

2 Press DUAL button repeatedly.

Not in the dual mode, pressing the **DUAL** button once will set the piano as Layer mode('LAr') and pressing the **DUAL** button once more will set it as Split mode(SPL).

After displaying 'SPL', the split voice is displayed on the screen.



☞ The default layer voice is Acoustic Bass(Ac.b).

3 Choose the desired split voice.

Press **DATA** buttons to choose the split voice.

Refer to page 12 for voice selection.

☞ The split volume can be adjusted. Refer to page 15.

4 Press DUAL button twice to turn off the split.

Layer(LAr) → Split(SPL) → Twin Piano(tn) → Quit

Changing the Split Point

Split Point refers to the point where the keyboard is divided.

While holding **DUAL** button, press the key that you wish to set as the split point. The LED displays the octave and the pitch name of the selected key. (e.g. Gb3, A4)

☞ The default split point is F#3 (third F# from the left, 'Gb3' in the screen)

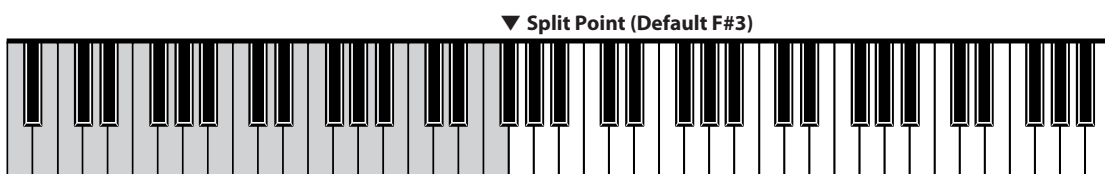

Secondary Volume

This determines the volume of the layer and split voice.

When the secondary volume is changed, the layer and split volume will be changed at the same time.

1 Press SETUP button once, then press DUAL button.

When **SETUP** button is pressed, the LED will show '---', then press **DUAL** button. The LED will show the secondary volume. Press **DATA** buttons to adjust the volume.

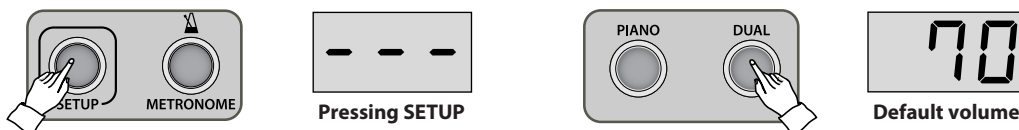

- ☞ Press both **DATA** buttons simultaneously to restore its default value (70).
- ☞ Range: 1 ~ 100 (Default: 70)
- ☞ Keep a **DATA** button pressed to quickly run through the values.

2 Press SETUP button to exit the secondary volume.

Twin Piano

Twin Piano divides the piano keyboard into two equal smaller ("twin") keyboards with nearly identical registers. This allows two people to play the piano simultaneously on the same range without running into each other.

1 Select a voice.

Refer to page 12 for voice selection.

2 Press DUAL repeatedly.

Not in the dual mode, pressing **DUAL** button once will set the piano as Layer mode('LAr') and pressing **DUAL** button twice more will set it as Twin Piano mode('tn').

After displaying 'tn', the twin(main) voice is displayed on the screen. The keyboard will be divided into two parts with nearly identical registers, with D#4 as the point of division.

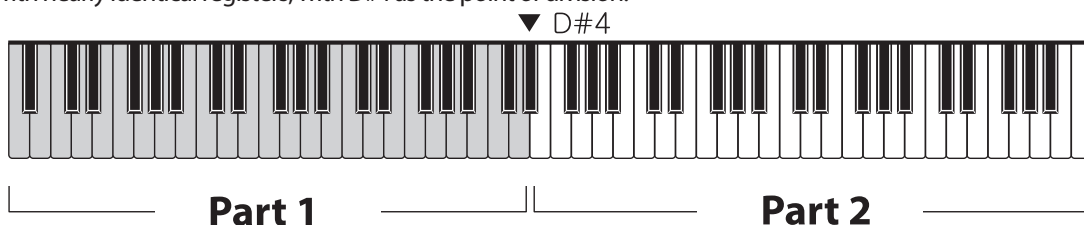

3 Press DUAL button once again to quit using Twin Piano.

Layer(LAr) → Split(SPL) → Twin Piano(tn) → Quit

Metronome

Metronome provides clicks over a steady beat to help the player keep in time while playing.

Turning Metronome On/Off

Press **METRONOME** to begin hearing metronome beats.
Press **METRONOME** again to turn off the metronome.

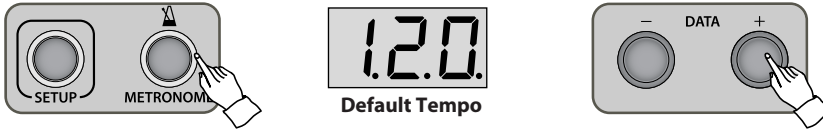

Adjusting Tempo

The range of metronome tempo is from 40 to 250 bpm (beats per minute). It may be adjusted by using **DATA** buttons.

- ☞ Keep a **DATA** button pressed to quickly run through the values.
- ☞ Pressing both **DATA** buttons simultaneously will restore the default tempo (120).
- ☞ Refer to page 25 for adjusting the metronome volume.

Adjusting Metronome Meter

1 Press **SETUP**, then press **METRONOME**.

When **SETUP** button is pressed, the LED will show '---', then **METRONOME** button is pressed, the LED will show the meter. Press **DATA** buttons to adjust the metronome meter.

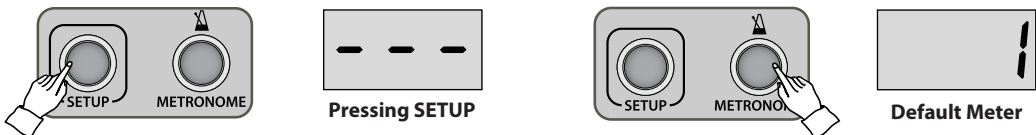

- ☞ Pressing both **DATA** buttons simultaneously will restore the default meter (1).
- ☞ Range: 1~12 (Default: 1)
- ☞ If **DATA** buttons are not used for about 10 seconds, setup mode will be quitted automatically.

2 Press **SETUP** button once again to quit setup mode.

Record

This piano features an extensive recording system to record the player's performance. There are 2 tracks and each track may record up to 5,000 notes.

Recording

1 Press REC/DEMO button.

The button will be lighted, and the **TRACK1/L** button will begin flashing. The Dual features may be used for recording.

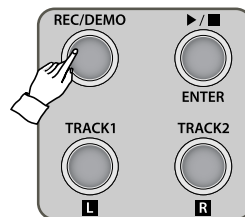

2 Record to Track1.

Play a key, or press ►/■/ENTER button to begin recording.

- ☞ While recording, **REC/DEMO** button and ►/■/ENTER button is flashing.
- ☞ Recording will terminate if the piano is not played for about 5 minutes.
- ☞ When the capacity limit is exceeded, the LED shows 'FUL' and recording will stop.
- ☞ If the piano malfunctions when exceeded, turn the piano off and on again.
- ☞ All settings are also recorded along. However, metronome clicks and tune are not recorded.

3 End recording Track1.

Press ►/■/ENTER button to stop recording to track1. **TRACK1/L** button will turn on. If desiring to hear what is recorded in Track 1, press ►/■/ENTER button once again.

4 Record to Track2.

Press **TRACK2/R** button, and then **TRACK2/R** button will be flashing.

If you want to mute track 1 while recording to track 2, press **TRACK1/L** button to turn it off. Record to track2 in the same way as recording track1.

Playing

1 Selecting Track

Select the desired track. After recording, both of the tracks are selected. Turn off the track you want to mute, then the track won't be played.

2 Press ►/■/ENTER button.

- ☞ Selected tracks are not be able to be changed while playing.
- ☞ When playback, ►/■/ENTER button will keep flashing.

3 Press REC/DEMO button again to quit recording and return to performance mode.

Erasing

Press and hold down a TRACK button until a 'bell' rings to erase the corresponding track. The LED will display 'dEL'.

Demo / Etude

This piano features an extensive bank of demonstrational recordings of 50 selected works all performed by professional pianists. It also includes a dedicated music data bank consisting of pedagogical etudes by Beyer (106), Czerny (100/30/40), Burgmüller (25) and selected sonatines for students (45).

Listening to Music

1 Press and hold down REC/DEMO button for 2~3 seconds.

The screen will show the first music group 'Pno' and REC/DEMO button will be lighted.



2 Select a music group.

There are 1 demo folder and 6 etudes folders.

Search the desired folder with DATA buttons and press ▶/■/ENTER button to enter it.

Display	Pno	br	bur	C10	C30	C40	Snt
Group	Piano	Beyer	Burgmüller	Czerny100	Czerny30	Czerny40	Sonatine

☞ To move to a different folder, select '---' on the first of the list and press ▶/■/ENTER button to move to the parent folder, where you may choose another folder to enter.

3 Select the desired piece to play. (Refer to page 20~22 for the music list)

Use the DATA buttons to reach the desired piece, then press ▶/■/ENTER button to play it.

4 Play the music.

Except for 'Pno' folder, you can turn off one hand part.

Playing one hand part

When a piece begins playing, both TRACK1/L and TRACK2 buttons are turned on. If you press TRACK1/L button, it will be turned off and the left hand part will be muted. Press TRACK2/R button to mute the right hand part.

Playing all pieces in succession

The player may play either all pieces in 1 folder in succession or just one piece. Refer to page 25 for this setting.

Adjusting Tempo

Each piece has its own default tempo. Each tempo is adjustable.

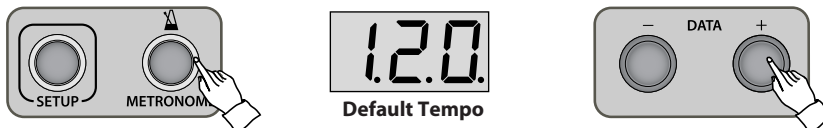

1 While playing a piece, press METRONOME button.

If you press **METRONOME** button, you can hear metronome beats of each piece's default tempo. The screen displays the default tempo.

☞ The pieces in 'Pno' folder are played freely by professional pianists. Its tempo is not mechanical but can be adjusted.

2 Use DATA buttons to adjust tempo.

If you stop playing, and then play it again or play another piece, the tempo will be set as its default. Pressing both **DATA** buttons simultaneously will restore the default Tempo.

3 Press METRONOME button once again to exit the metronome.

The screen returns to the previous display.

Adjusting Volume

The volume of the Demo/Etudes music may be adjusted.



1 In Demo mode, press SETUP button once.

Pressing **SETUP** button will show the current music volume in the screen. Use **DATA** buttons to adjust the volume.

- ☞ Keep a **DATA** button pressed to quickly run through the values.
- ☞ Pressing both **DATA** buttons simultaneously will restore the default volume (65).
- ☞ The volume also may be adjusted in the Function menu(F06). Refer to page 25.

2 Press SETUP button to exit the adjusting volume.

☞ If **DATA** buttons are not used for about 10 seconds, setup mode will be quitted automatically.

Demo List (Pno)

Display	Title	Composer
P01	Etude op.10 no.1 in C major 'Waterfall'	Chopin, Fryderyk Franciszek
P02	Etude op.10 no.4 in c-sharp minor 'Torrent'	
P03	Etude op.10 no.5 in G-flat major 'Black Keys'	
P04	Etude op.25 no.9 in G-flat major 'Butterfly'	
P05	Nocturne op.9 no.1 in b-flat minor- Larghetto	
P06	Nocturne op.9 no.2 in E-flat major- Andante	
P07	Nocturne op.27 no.2 in D-flat major- Lento sostenuto	
P08	Nocturne op.32 no.1 in B major- Andante sostenuto	
P09	Nocturne op.72 no.1 in e minor- Andante	
P10	Piano sonata op.58 no.3- 4 Finale-Presto non tanto; Agitato in b minor	
P11	Mazurka op.7 no.1	
P12	Mazurka op.30 no.2 in b minor- Vivace	
P13	Mazurka op.67 no.3 in C major- Sllegretto	
P14	Polonaise op.40 no.1 in A major 'Military Polonaise'	
P15	Waltz op.34 no.1 in A-flat major- Vivace	
P16	Waltz op.64 no.1 in D-flat major- Molto vivace (Minute Waltz)	
P17	Waltz op.64 no.2 in c-sharp minor- Tempo giusto	
P18	Waltz op.69 no.2 in b minor	
P19	Impromptu op.66 in c-sharp minor (Fantaisie-impromptu)	
P20	Ballade no.1 op.23 in g minor	
P21	Ballade no.3 op.47 in A flat major	
P22	Prelude op.28 no.1 in C major- Agitato	
P23	Prelude op.28 no.16 in b-flat minor- Presto con fuoco	
P24	Piano Sonata no.10 in C major, KV330-1 Allegro moderato	Mozart, Wolfgang Amadeus
P25	Piano Sonata no.11 in A major, KV331-3 Alla turca : Allegretto	
P26	Piano Sonata no.14 in C minor, KV457-2 Adagio	
P27	Piano Sonata no.14 in C minor, KV457-3 Allego assai	
P28	Variations "Ah! Vous dirai-je, Maman", KV265	
P29	Rondo in D major, KV485	
P30	Sonata no.8 in c minor, 'Pathetique' 1 Grave- Allegro di molto e con brio	Beethoven, Ludwig van
P31	Sonata no.8 in c minor, 'Pathetique' 2 Adagio cantabile	
P32	Sonata no.8 in c minor, 'Pathetique' 3 Allegro	
P33	Arabesque No.1 in E major	Debussy, Claude Achille
P34	Suite bergamesque 1. Prelude	
P35	Suite bergamesque 3. Clair de lune	
P36	Petite Suite, for piano 4-hands 2. Cortege	
P37	Scenes from Childhood op.15-1 Of foreign lands and peoples in G major	Schumann, Robert
P38	12 Transcendental Etudes, S.139-4 Mazeppa in d minor	Liszt, Franz
P39	The flight of the bumble bee (by S. Rachmaninov)	Rimsky-Korsakov, Nikolai
P40	Trois Gymnopedies 1. Lent et douloureux	Satie, Erik
P41	36 Fantasie per clavicembalo (TWV 33) 1. Allegro	Telemann, Georg Philipp
P42	36 Fantasie per clavicembalo (TWV 33) 3. Vivace	
P43	36 Fantasie per clavicembalo (TWV 33) 5. Vivace	
P44	36 Fantasie per clavicembalo (TWV 33) 6. Tempo di minuetto	
P45	36 Fantasie per clavicembalo (TWV 33) 12. Vivace	
P46	Children's Album, Op.39 No.4 Mama	Tchaikovsky, Pyotr Ilyich
P47	Prelude in C major, BWV933	Bach, Johann Sebastian
P48	Preludium und Fuge in B flat major, BWV560- Pipe Organ music-	
P49	Das wohltemperierte Klavier Vol. I -1.Preludio in C major, BWV846	
P50	Das wohltemperierte Klavier Vol. I -1.Fuga in C major, BWV846	

Beyer / Czerny Etudes (br / C10, C30, C40)

Demo / Etude

Beyer / Czerny Etudes
(br / C10, C30, C40)

Display	Title	Display	Title	Display	Title	Display	Title
	Beyer						
001	Beyer 1	076	Beyer 76	C44	Czerny100-44	C18	Czerny30-18
002	Beyer 2	077	Beyer 77	C45	Czerny100-45	C19	Czerny30-19
003	Beyer 3	078	Beyer 78	C46	Czerny100-46	C20	Czerny30-20
004	Beyer 4	079	Beyer 79	C47	Czerny100-47	C21	Czerny30-21
005	Beyer 5	080	Beyer 80	C48	Czerny100-48	C22	Czerny30-22
006	Beyer 6	081	Beyer 81	C49	Czerny100-49	C23	Czerny30-23
007	Beyer 7	082	Beyer 82	C50	Czerny100-50	C24	Czerny30-24
008	Beyer 8	083	Beyer 83	C51	Czerny100-51	C25	Czerny30-25
009	Beyer 9	084	Beyer 84	C52	Czerny100-52	C26	Czerny30-26
010	Beyer 10	085	Beyer 85	C53	Czerny100-53	C27	Czerny30-27
011	Beyer 11	086	Beyer 86	C54	Czerny100-54	C28	Czerny30-28
012	Beyer 12	087	Beyer 87	C55	Czerny100-55	C29	Czerny30-29
013	Beyer 13	088	Beyer 88	C56	Czerny100-56	C30	Czerny30-30
014	Beyer 14	089	Beyer 89	C57	Czerny100-57		
015	Beyer 15	090	Beyer 90	C58	Czerny100-58		
016	Beyer 16	091	Beyer 91	C59	Czerny100-59		
017	Beyer 17	092	Beyer 92	C60	Czerny100-60	C01	Czerny40-1
018	Beyer 18	093	Beyer 93	C61	Czerny100-61	C02	Czerny40-2
019	Beyer 19	094	Beyer 94	C62	Czerny100-62	C03	Czerny40-3
020	Beyer 20	095	Beyer 95	C63	Czerny100-63	C04	Czerny40-4
021	Beyer 21	096	Beyer 96	C64	Czerny100-64	C05	Czerny40-5
022	Beyer 22	097	Beyer 97	C65	Czerny100-65	C06	Czerny40-6
023	Beyer 23	098	Beyer 98	C66	Czerny100-66	C07	Czerny40-7
024	Beyer 24	099	Beyer 99	C67	Czerny100-67	C08	Czerny40-8
025	Beyer 25	100	Beyer 100	C68	Czerny100-68	C09	Czerny40-9
026	Beyer 26	101	Beyer 101	C69	Czerny100-69	C10	Czerny40-10
027	Beyer 27	102	Beyer 102	C70	Czerny100-70	C11	Czerny40-11
028	Beyer 28	103	Beyer 103	C71	Czerny100-71	C12	Czerny40-12
029	Beyer 29	104	Beyer 104	C72	Czerny100-72	C13	Czerny40-13
030	Beyer 30	105	Beyer 105	C73	Czerny100-73	C14	Czerny40-14
031	Beyer 31	106	Beyer 106	C74	Czerny100-74	C15	Czerny40-15
032	Beyer 32			C75	Czerny100-75	C16	Czerny40-16
033	Beyer 33		Czerny100	C76	Czerny100-76	C17	Czerny40-17
034	Beyer 34	C01	Czerny100-1	C77	Czerny100-77	C18	Czerny40-18
035	Beyer 35	C02	Czerny100-2	C78	Czerny100-78	C19	Czerny40-19
036	Beyer 36	C03	Czerny100-3	C79	Czerny100-79	C20	Czerny40-20
037	Beyer 37	C04	Czerny100-4	C80	Czerny100-80	C21	Czerny40-21
038	Beyer 38	C05	Czerny100-5	C81	Czerny100-81	C22	Czerny40-22
039	Beyer 39	C06	Czerny100-6	C82	Czerny100-82	C23	Czerny40-23
040	Beyer 40	C07	Czerny100-7	C83	Czerny100-83	C24	Czerny40-24
041	Beyer 41	C08	Czerny100-8	C84	Czerny100-84	C25	Czerny40-25
042	Beyer 42	C09	Czerny100-9	C85	Czerny100-85	C26	Czerny40-26
043	Beyer 43	C10	Czerny100-10	C86	Czerny100-86	C27	Czerny40-27
044	Beyer 44	C11	Czerny100-11	C87	Czerny100-87	C28	Czerny40-28
045	Beyer 45	C12	Czerny100-12	C88	Czerny100-88	C29	Czerny40-29
046	Beyer 46	C13	Czerny100-13	C89	Czerny100-89	C30	Czerny40-30
047	Beyer 47	C14	Czerny100-14	C90	Czerny100-90	C31	Czerny40-31
048	Beyer 48	C15	Czerny100-15	C91	Czerny100-91	C32	Czerny40-32
049	Beyer 49	C16	Czerny100-16	C92	Czerny100-92	C33	Czerny40-33
050	Beyer 50	C17	Czerny100-17	C93	Czerny100-93	C34	Czerny40-34
051	Beyer 51	C18	Czerny100-18	C94	Czerny100-94	C35	Czerny40-35
052	Beyer 52	C19	Czerny100-19	C95	Czerny100-95	C36	Czerny40-36
053	Beyer 53	C20	Czerny100-20	C96	Czerny100-96	C37	Czerny40-37
054	Beyer 54	C21	Czerny100-21	C97	Czerny100-97	C38	Czerny40-38
055	Beyer 55	C22	Czerny100-22	C98	Czerny100-98	C39	Czerny40-39
056	Beyer 56	C23	Czerny100-23	C99	Czerny100-99	C40	Czerny40-40
057	Beyer 57	C24	Czerny100-24	C00	Czerny100-100		
058	Beyer 58	C25	Czerny100-25				
059	Beyer 59	C26	Czerny100-26				
060	Beyer 60	C27	Czerny100-27				
061	Beyer 61	C28	Czerny100-28	C01	Czerny30-1		
062	Beyer 62	C29	Czerny100-29	C02	Czerny30-2		
063	Beyer 63	C30	Czerny100-30	C03	Czerny30-3		
064	Beyer 64	C31	Czerny100-31	C04	Czerny30-4		
065	Beyer 65	C32	Czerny100-32	C05	Czerny30-5		
066	Beyer 66	C33	Czerny100-33	C06	Czerny30-6		
067	Beyer 67	C34	Czerny100-34	C07	Czerny30-7		
068	Beyer 68	C35	Czerny100-35	C08	Czerny30-8		
069	Beyer 69	C36	Czerny100-36	C09	Czerny30-9		
070	Beyer 70	C37	Czerny100-37	C10	Czerny30-10		
071	Beyer 71	C38	Czerny100-38	C11	Czerny30-11		
072	Beyer 72	C39	Czerny100-39	C12	Czerny30-12		
073	Beyer 73	C40	Czerny100-40	C13	Czerny30-13		
074	Beyer 74	C41	Czerny100-41	C14	Czerny30-14		
075	Beyer 75	C42	Czerny100-42	C15	Czerny30-15		
		C43	Czerny100-43	C16	Czerny30-16		
				C17	Czerny30-17		

Burgmüller Etudes / Sonatines (bur / Snt)

Display	Title	Display	Title	Composer
b01	Burgmüller 25 Etude No.1 <i>La Candeur</i>	01.1	Sonatines op.20 no.1 1	F. Kuhlau
		01.2	Sonatines op.20 no.1 2	
b02	Burgmüller 25 Etude No.2 <i>L'Arabesque</i>	01.3	Sonatines op.20 no.1 3	
		02.1	Sonatines op.20 no.2 1	
b03	Burgmüller 25 Etude No.3 <i>La Pastorale</i>	02.2	Sonatines op.20 no.2 2	
		02.3	Sonatines op.20 no.2 3	
b04	Burgmüller 25 Etude No.4 <i>La Petite Reunion</i>	03.1	Sonatines op.20 no.3 1	
		03.2	Sonatines op.20 no.3 2	
b05	Burgmüller 25 Etude No.5 <i>Innocence</i>	03.3	Sonatines op.20 no.3 3	
		04.1	Sonatines op.55 no.1 1	
b06	Burgmüller 25 Etude No.6 <i>Progrès</i>	04.2	Sonatines op.55 no.1 2	M. Clementi
		05.1	Sonatines op.55 no.2 1	
b07	Burgmüller 25 Etude No.7 <i>La Courant Limpide</i>	05.2	Sonatines op.55 no.2 2	
		05.3	Sonatines op.55 no.2 3	
b08	Burgmüller 25 Etude No.8 <i>La Gracieuse</i>	06.1	Sonatines op.55 no.3 1	
		06.2	Sonatines op.55 no.3 2	
b09	Burgmüller 25 Etude No.9 <i>La Chasse</i>	07.1	Sonatines op.36 no.1 1	
b10	Burgmüller 25 Etude No.10 <i>Tendre Fleur</i>	07.2	Sonatines op.36 no.1 2	
		07.3	Sonatines op.36 no.1 3	
b11	Burgmüller 25 Etude No.11 <i>La Bergeronnette</i>	08.1	Sonatines op.36 no.2 1	
		08.2	Sonatines op.36 no.2 2	
b12	Burgmüller 25 Etude No.12 <i>L'adieu</i>	08.3	Sonatines op.36 no.2 3	
		09.1	Sonatines op.36 no.3 1	
b13	Burgmüller 25 Etude No.13 <i>Consolation</i>	09.2	Sonatines op.36 no.3 2	
		09.3	Sonatines op.36 no.3 3	
b14	Burgmüller 25 Etude No.14 <i>La Styrienne</i>	10.1	Sonatines op.36 no.4 1	
		10.2	Sonatines op.36 no.4 2	
b15	Burgmüller 25 Etude No.15 <i>Ballade</i>	10.3	Sonatines op.36 no.4 3	
		11.1	Sonatines op.36 no.5 1	
b16	Burgmüller 25 Etude No.16 <i>Douce Plainte</i>	11.2	Sonatines op.36 no.5 2	
		11.3	Sonatines op.36 no.5 3	
b17	Burgmüller 25 Etude No.17 <i>La Babillarde</i>	12.1	Sonatines op.36 no.6 1	
		12.2	Sonatines op.36 no.6 2	
b18	Burgmüller 25 Etude No.18 <i>Inquiétude</i>	13.1	Sonatines Hob. 16-35 1	J.Haydn
b19	Burgmüller 25 Etude No.19 <i>Ave Maria</i>	13.2	Sonatines Hob. 16-35 2	
		13.3	Sonatines Hob. 16-35 3	
b20	Burgmüller 25 Etude No.20 <i>La Tarentelle</i>	14.1	Sonatines K.545 1	W.A.Mozart
b21	Burgmüller 25 Etude No.21 <i>L'harmonie Des Anges</i>	14.2	Sonatines K.545 2	
		14.3	Sonatines K.545 3	
b22	Burgmüller 25 Etude No.22 <i>Barcarolle</i>	15.1	Sonatines op.49 no.2 1	L.V.Beethoven
b23	Burgmüller 25 Etude No.23 <i>Le Retour</i>	15.2	Sonatines op.49 no.2 2	
		16.1	Sonatines op.49 no.1 1	
b24	Burgmüller 25 Etude No.24 <i>L'hirondelle</i>	16.2	Sonatines op.49 no.1 2	
b25	Burgmüller 25 Etude No.25 <i>La Chevaleresque</i>	17.1	Sonatines op.20 no.1 1	J.L.Dussek
		17.2	Sonatines op.20 no.1 2	

☞ In Sonatines, the first two digits are piece number and the third digit means a movement.

Functions

This piano offers extensive utilities designed to allow adjusting the piano to suit either personal preferences of a user or a given performance condition.

Using SETUP

By using **SETUP** button, many diverse parameters of the piano may be set.

Press **SETUP** button once, it is lighted and the LED shows '---'.

Navigate through the parameters (F01, F02, ..., F15) by using **DATA** buttons.

Press **▶/■/ENTER** button to enter a parameter and adjust its value with **DATA** buttons.

Press **SETUP** to quit setup mode and return to performance mode.

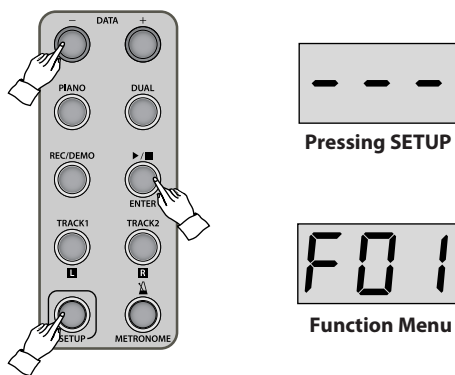

- ☞ The LED will show the current value.
- ☞ Pressing both **DATA** buttons simultaneously will restore the default value.
- ☞ If **DATA** buttons are not used for about 10 seconds, setup mode will be quitted automatically.
- ☞ Your last configurations will be retained until the piano is turned off.

Display	Function Name	Range	Default
F01	Master Tune	-50 ~ 00 ~ +50	00
F02	Key Transpose	-12 ~ 00 ~ +12	00
F03	Brilliance	-50 ~ 00 ~ +50	00
F04	Touch	OFF, SOF, nor, Hrd	nor
F05	Fixed Touch Velocity	20 ~ 127	80
F06	Demo Volume	20 ~ 100	65
F07	Play All Music	On, OFF	On
F08	Metronome Volume	20 ~ 100	80
F09	Reverb Type	r-0 ~ r-5	r-2
F10	Effect Type	c-0 ~ c-3	c-0
F11	Reverb Volume	0 ~ 100	40
F12	Effect Volume	0 ~ 100	70
F13	MIDI Local Control	On, OFF	On
F14	Hybrid USB Audio	On, OFF	OFF
F15	Reset	Enter	-

F01 Master Tune

Tune allows fine tuning of the piano by units of cents, which is useful when the piano is to be played alongside other acoustic instruments that are tune-sensitive.

- ☞ Cent: A unit of pitch; 1 cent equals to a hundredth of a semitone.
- ☞ Use **DATA** buttons to adjust the tuning of the instrument by units of cents.
- ☞ Range: - 50 ~ 00 ~ + 50 cents (Default: 00)
- ☞ Press both **DATA** buttons simultaneously to restore its default value (00).
- ☞ Refer to page 23 for using the **SETUP** button.

F02 Key Transpose

This piano may be transposed up or down by units of semitones. It may be done to avoid having to change fingerings to accommodate playing with a singer or other instruments who are limited by their registers.

- ☞ Range: -12 semitones ~ 00 ~ +12 semitones (Default: 00)
- ☞ Press both **DATA** buttons simultaneously to restore its default value (00).
- ☞ Refer to page 23 for using the **SETUP** button.

F03 Brilliance

Brilliance determines the timbre of the piano sound. When Brilliance is increased the piano sound gains more pronouncing clarity, and when decreased the sound is softened.

- ☞ Range: -50 ~ 00 ~ +50 (Default: 00)
- ☞ Press both **DATA** buttons simultaneously to restore its default value (00).
- ☞ Refer to page 23 for using the **SETUP** button.

F04 Touch

The Touch parameter determines how responsive the volume of a note is to the speed of the player's keystroke. The piano offers 4 different Touch settings to suit different types of players.

Display	Settings	Description
SOF	Soft	Soft setting allows the player to produce large sound without necessarily using large forces, and are designed to suit players with less than ordinary finger strength.
nor	Normal	Normal setting represents the responsiveness of ordinary acoustic pianos. (Default: Normal)
Hrd	Hard	Hard setting requires the player to play quite hard to produce loud sounds, and suits players with strong finger strength or desire more delicate control of soft melodies.
OFF	Fixed	Under this unique setting, all notes are pronounced equally regardless of the player's finger velocity.

- ☞ Press both **DATA** buttons simultaneously to restore its default value (nor).
- ☞ Refer to page 23 for using the **SETUP** button.

F05 Fixed Touch Velocity

When the Touch parameter is set to 'Fixed', all notes played will have the same velocity regardless of how it is played. You may also set the constant volume level that you wish to use while using Fixed Velocity.

- ☞ Range: 20~127 (Default: 80)
- ☞ Press both **DATA** buttons simultaneously to restore its default value (80).
- ☞ Refer to page 23 for using the **SETUP** button.

F06 Demo Volume

The volume of the Demo/Etudes music recordings may be adjusted.

- ☞ Range: 20 ~ 100 (Default: 65)
- ☞ Press both **DATA** buttons simultaneously to restore its default value (65).
- ☞ Refer to page 23 for using the **SETUP** button.

F07 Play All Music

With this setting ON, a Demo piece is automatically followed by the next piece in the same music group, continuing until the end of that music group is reached.

- ☞ Range: ON, OFF (Default: ON)
- ☞ Press both **DATA** buttons simultaneously to restore its default value (ON).
- ☞ Refer to page 23 for using the **SETUP** button.

F08 Metronome Volume

The volume of the Metronome may be adjusted.

- ☞ Range: 20 ~ 100 (Default: 80)
- ☞ Press both **DATA** buttons simultaneously to restore its default value (80).
- ☞ Refer to page 16 for Metronome settings.
- ☞ Refer to page 23 for using the **SETUP** button.

F09 Reverb Type

You may choose from the 5 available Reverb types.

Display	r-0	r-1	r-2(default)	r-3	r-4	r-5
Type	off	Room 1	Room 2	Hall	Plate	Pan Delay

- ☞ Press both **DATA** buttons simultaneously to restore its default value (r-2).
- ☞ Refer to page 23 for using the **SETUP** button.

F10 Effect Type

You may choose from the 3 available Effect types.

Display	C-0(default)	C-1	C-2	C-3
Type	off	Chorus1	Chorus2	Short Flanger

- ☞ Press both **DATA** buttons simultaneously to restore its default value (C-0).
- ☞ Refer to page 23 for using the **SETUP** button.

F11 Reverb Volume

The volume of the Reverb may be adjusted.

- ☞ Range: 0 ~ 100 (Default: 40)
- ☞ Press both **DATA** buttons simultaneously to restore its default value (40).
- ☞ Refer to page 25 for Reverb type.
- ☞ Refer to page 23 for using the **SETUP** button.

F12 Effect Volume

The volume of the Effect may be adjusted.

- ☞ Range: 0 ~ 100 (Default: 70)
- ☞ Press both **DATA** buttons simultaneously to restore its default value (70).
- ☞ Refer to page 25 for Effect type.
- ☞ Refer to page 23 for using the **SETUP** button.

F13 MIDI Local Control

Intended for MIDI users, this setting is used mainly when connecting the piano to external devices like computers so as to use the piano as a MIDI input device. Setting Local Control to Off prevents the input data of the keyboard from being sent to the internal speaker system of the piano, thereby silencing it while the data is output as MIDI signals to any external devices connected to the piano.

- ☞ Range: ON, OFF (Default: ON)
- ☞ Press both **DATA** buttons simultaneously to restore its default value (ON).
- ☞ Refer to page 23 for using the **SETUP** button.

F14 Hybrid USB Audio

This setting determines the activation of USB Audio. Select 'ON' before using USB audio function. If 'OFF' is selected, you can't use USB Audio function. When the settings are changed, the piano will be turned off and on automatically. This setting is retained even after the piano is turned off and on.

- ☞ Range: ON, OFF (Default: OFF)
- ☞ Press both **DATA** buttons simultaneously to restore its default value (OFF).
- ☞ Some notes may be lost when connected via USB.
- ☞ Refer to page 23 for using the **SETUP** button.
- ☞ Refer to page 9 for connecting to a computer.

F15 Reset

Initializes ALL settings and parameters to their default values, except for USB audio.

When 'rSt(reset)' displays on the screen, press ►/■/ENTER button. Then all settings will be initialized and the LED will show '----'.

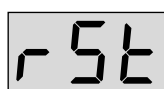

Reset



- ☞ While the LED showing 'rSt', press **SETUP** button once again if you don't want to reset the settings.
- ☞ Refer to page 23 for using the **SETUP** button.

MEMO

MEMO

A large, empty rectangular box with a thin black border, occupying most of the page. It is intended for writing the content of the memo.

MIDI Chart

MIDI Implementation Chart

Function		Recognized	Transmitted	Remark
Basic Channel	Default	ALL	1-3	
Mode	Default	OMNI OFF, POLY	OMNI OFF, POLY	
Note ON/OFF	9nH kk wv	O	O	#kk:note ON (0-127) #vv:velocity (1-127)
Pitch Bender	EnH bi bh	O	O	Maximum swing +/- 1 tone
Control Change	00 BnH 00H cc	O	X	Bank Select
	01 BnH 01H cc	O	X	Modulation Wheel
	05 BnH 05H cc	O	X	Portamento Time
	06 BnH 06H cc	O	X	Data Entry
	07 BnH 07H cc	O	X	Volume
	10 BnH 0AH cc	O	X	Pan Out
	11 BnH 0BH cc	O	X	Expression
	64 BnH 40H cc	O	O	Damper Pedal
	65 BnH 41H cc	O	X	Portamento ON/OFF
	66 BnH 42H cc	O	O	Sostenuto Pedal
	67 BnH 43H cc	O	O	Soft Pedal
	80 BnH 80H wv	O	X	Reverb Prog.(v=00H-70H)
	81 BnH 51H wv	O	X	Chorus Prog.
	91 BnH 5BH wv	O	O	Reverb Send Level
	93 BnH 5DH wv	O	O	Chorus Send Level
	120 BnH 78H 00H	O	X	All Sound Off
121 BnH 79H 00H	O	X	Reset All Controller	
123 BnH 7BH 00H	O	X	All Notes Off	
126 BnH 7EH 00H	O	X	Mono On	
127 BnH 7FH 00H	O	X	Poly On	
Program Change	CnH PP	O	O	Sounds/Drum Set List
System Exclusive	General MIDI Reset	X	X	

O:Yes, X:No

GM Voice & Percussion

GM Voice(when connected to MIDI)

GM #	VOICE	GM #	VOICE
001	Grand Piano 1	065	Soprano Saxophone
002	Grand Piano 2	066	Alto Saxophone
003	Grand Piano 3	067	Tenor Saxophone
004	Honky Tonk	068	Baritone Saxophone
005	Electric Piano 1	069	Oboe
006	Electric Piano 2	070	English Horn
007	Harpsichord	071	Bassoon
008	Clavinet	072	Clarinet
009	Celesta	073	Piccolo
010	Glockenspiel	074	Flute
011	Music Box	075	Recorder
012	Vibraphone	076	Pan Flute
013	Marimba	077	Bottle Blow
014	Xylophone	078	Shakuhachi
015	Tubular Bell	079	Whistle
016	Dulcimer	080	Ocarina
017	Electric Organ 1	081	Square
018	Electric Organ 2	082	Sawtooth
019	Electric Organ 3	083	Calliope
020	Pipe Organ	084	Chiffer
021	Reed Organ	085	Charang
022	Accordion	086	Solo Vox
023	Harmonica	087	Fifths
024	Bandonion	088	Bass Lead
025	Nylon Guitar	089	Fantasia
026	Steel Guitar	090	Warm Pad
027	Jazz Guitar	091	Poly Synth
028	Clean Guitar	092	Space Vox
029	Muted Guitar	093	Bow Glass
030	Drive Guitar	094	Metal Pad
031	Lead Guitar	095	Halo Pad
032	Harmonic Guitar	096	Sweep Pad
033	Acoustic Bass	097	Ice Rain
034	Finger Bass	098	Sound Track
035	Pick Bass	099	Crystal
036	Fretless Bass	100	Atmosphere
037	Slap Bass 1	101	Brightness
038	Slap Bass 2	102	Goblin
039	Synth Bass 1	103	Echo Drop
040	Synth Bass 2	104	Star Theme
041	Violin	105	Sitar
042	Viola	106	Banjo
043	Cello	107	Shamishen
044	Contra Bass	108	Koto
045	Tremolo Strings	109	Kalimba
046	Pizzicato Strings	110	Bagpipe
047	Harp	111	Fiddle
048	Timpani	112	Shanai
049	Strings	113	Tinkle Bell
050	Slow Strings	114	Agogo
051	Synth Strings 1	115	Steel Drum
052	Synth Strings 2	116	Wood Block
053	Choir Aahs	117	Taiko
054	Voice Oohs	118	Melody Tom
055	Synth Voice	119	Synth Drum
056	Orchestra Hit	120	Reversed Cymbal
057	Trumpet	121	Guitar Noise
058	Trombone	122	Breath Noise
059	Tuba	123	Sea Shore
060	Muted Trumpet	124	Birds
061	French Horn	125	Telephone
062	Brass Section	126	Helicopter
063	Synth Brass 1	127	Applause
064	Synth Brass 2	128	Gunshot

Percussion

	Prog1 [Standard Drum]	Prog58 [SFX]
27 - D#1	High Q	Conga
28 - E1	Slap	Whistle
29 - F1	Scratch Push	Small Drum
30 - F#1	Scratch Pull	Cymbal
31 - G1	Sticks	Castanets
32 - G#1	Square Click	Triangle
33 - A1	Metronome Click	Maracas
34 - A#1	Metronome Bell	Timbale
35 - B1	Kick drum2/Jazz BD2	Belltrees
36 - C2	Kick drum1/Jazz BD1	Wood Block
37 - C#2	Side Stick	Jingle Bell
38 - D2	Snare Drum1	Hand Clap
39 - D#2	Hand Clap	Jing
40 - E2	Snare Drum2	One
41 - F2	Low Floor Tom	Two
42 - F#2	Closed Hi Hat [EXC1]	Laughing
43 - G2	High Floor Tom	Three
44 - G#2	Pedal Hi-Hat [EXC1]	Bugs
45 - A2	Low Tom	Four
46 - A#2	Open Hi-Hat [EXC1]	Elf
47 - B2	Low-Mid Tom	Five
48 - C3	Hi Mid Tom	Six
49 - C#3	Crash Cymbal 1	Korean Drum 1
50 - D3	High Tom	Seven
51 - D#3	Ride Cymbal 1	Korean Drum 2
52 - E3	Chinese Cymbal	Eight
53 - F3	Ride Bell	Nine
54 - F#3	Tambourine	Korean Drum 3
55 - G3	Splash Cymbal	Ten
56 - G#3	Cowbell	Korean Drum 4
57 - A3	Crash Cymbal 2	Rocket
58 - A#3	Vibraslap	Korean Drum 5
59 - B3	Ride Cymbal2	Short/Long
60 - C4	Hi Bongo	Soft/Loud
61 - C#4	Low Bongo	Cuckoo
62 - D4	Mute Hi Conga	Good/Very Good
63 - D#4	Open Hi Conga	Bush Warbler
64 - E4	Low Conga	Birds
65 - F4	High Timbale	Hen
66 - F#4	Low Timbale	Duck
67 - G4	High Timbale	Chick/Chicken
68 - G#4	Low Agogo	Dog
69 - A4	Cabasa	Cat
70 - A#4	Maracas	Pig
71 - B4	Short Whistle[EXC2]	Goat
72 - C5	Long Whistle[EXC2]	Cow
73 - C#5	Short Guiro[EXC3]	Korean Cymbal 1
74 - D5	Long Guiro[EXC3]	Horse
75 - D#5	Claves	Korean Cymbal 2
76 - E5	Hi Wood Block	Frog/Frogs
77 - F5	Low Wood Block	Swan + Bubble
78 - F#5	Mute Cuica[EXC4]	Splash
79 - G5	Open Cuica[EXC4]	Wolf
80 - G#5	Mute Triangle[EXC5]	Comic Sound
81 - A5	Open Triangle[EXC5]	Tiger
82 - A#5	Shaker	Children's Laughing
83 - B5	Jingle Bell	Elephant
84 - C6	Belltrees	Bear
85 - C#6	Castanets	Korean Drum 7
86 - D6	Mute Surdo[EXC6]	Telephone Bell
87 - D#6	Open Surdo[EXC6]	Korean Drum 8
88 - E6		Bicycle Bell

※ Prog. 58 (SFX) have additional sound effects on the lowest (A0~D1) and highest (F6~C8) keys that are excluded from the chart due to its limit of range.

Trouble shooting

If a problem occurs while using this product, check the points listed below first prior to contacting customer service.

Problem	Cause	Solution
The piano does not turn on.	<ol style="list-style-type: none">1) The power cord is not properly plugged.2) The power switch is not pressed. (The button is lighted when it is pressed.)	<ol style="list-style-type: none">1) Properly plug the power cord.2) Press the power switch.3) Contact customer service.
The speakers produce no sound when a key is played.	<ol style="list-style-type: none">1) The master volume is set to minimum.2) A headphone is connected.3) The power connection jack of the power cord is not properly connected to the product.4) The treble/bass volume is set to minimum.	<ol style="list-style-type: none">1) Increase the master volume.2) Disconnect the headphone.3) Properly connect the power connection jack to the product.4) Increase the part volumes.
There are notable difference between the volumes of the main voice and the secondary voice.	<ol style="list-style-type: none">1) The secondary voice volume is set to a wrong value.	<ol style="list-style-type: none">1) Set the secondary voice volume properly.
Random noise is heard when using the product.	<ol style="list-style-type: none">1) Other electric products such as a refrigerator or an electric washer are operating nearby.	<ol style="list-style-type: none">1) Move the product faraway from other electric products, particularly those that use motors.
No sound is heard when using the product connected to an external sound device.	<ol style="list-style-type: none">1) The master volume is set to minimum.2) The connecting cord is either cut or damaged.	<ol style="list-style-type: none">1) Increase the master volume.2) Replace the cord.

Product Specifications

Keyboard	New RHA
Touch	Off, Soft, Normal, Hard
Maximum Polyphony	81
Voices	18 Voices, 1 Drum Set, 1 Effect Set (When connected to MIDI, GM128 Voices)
Features	Layer Split Twin Piano Transpose Master Tune
DSP	Reverb, Effect
Demo	50
Educational Music	Beyer/Czerny/Burgmüller etudes, selected Sonatines
Metronome	Yes (Tempo, Meter, Volume Adjustable)
Display	LED
Recording	Real-time recording 2 Tracks About 5,000 notes per track
Pedals	3(Soft, Sostenuto, Sustain)
Volume Control	Secondary / Demo / Metronome
Terminals	Audio IN/OUT USB TO HOST Pedal 2 Headphones
Speakers	(3×6) INCH × 2 STEREO 12W + 12W
Power	AC Adaptor
Consumer Power	23W
Accessories	Manual, AC Adaptor



DYNATONE CORP.

www.dynatone.biz